

# EFFICIENT UNFOLDING OF COLOURED PETRI NETS WITH INTERVAL DECISION DIAGRAMS

SCHWARICK - ROHR - LIU - ASSAF - CHODAK - HEINER

BRANDENBURG TECHNICAL UNIVERSITY COTTBUS-SENFTEMBERG  
COMPUTER SCIENCE INSTITUTE

[HTTPS://WWW-DSSZ.INFORMATIK.TU-COTTBUS.DE](https://www-dssz.informatik.tu-cottbus.de)

# EFFICIENT UNFOLDING OF COLOURED PETRI NETS WITH INTERVAL DECISION DIAGRAMS

SCHWARICK - ROHR - LIU - ASSAF - CHODAK - HEINER  
BRANDENBURG TECHNICAL UNIVERSITY COTTBUS-SENFTENBERG  
COMPUTER SCIENCE INSTITUTE

# COLOURED PETRI NETS

**WHAT FOR ?**

## THE SIR MODEL

[ [https://en.wikipedia.org/wiki/Compartmental\\_models\\_in\\_epidemiology#The\\_SIR\\_model](https://en.wikipedia.org/wiki/Compartmental_models_in_epidemiology#The_SIR_model) ]

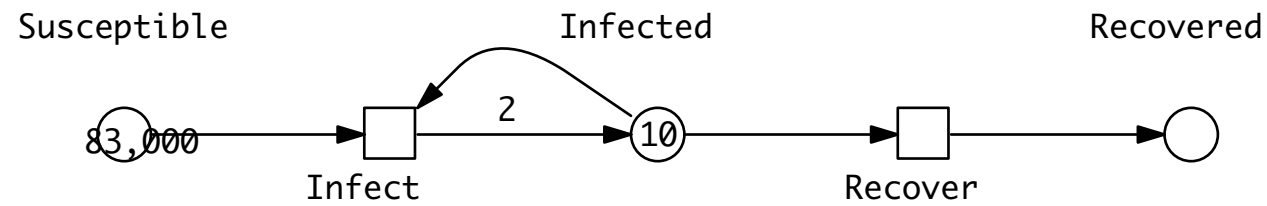

## THE SIR MODEL

[ [https://en.wikipedia.org/wiki/Compartmental\\_models\\_in\\_epidemiology#The\\_SIR\\_model](https://en.wikipedia.org/wiki/Compartmental_models_in_epidemiology#The_SIR_model) ]

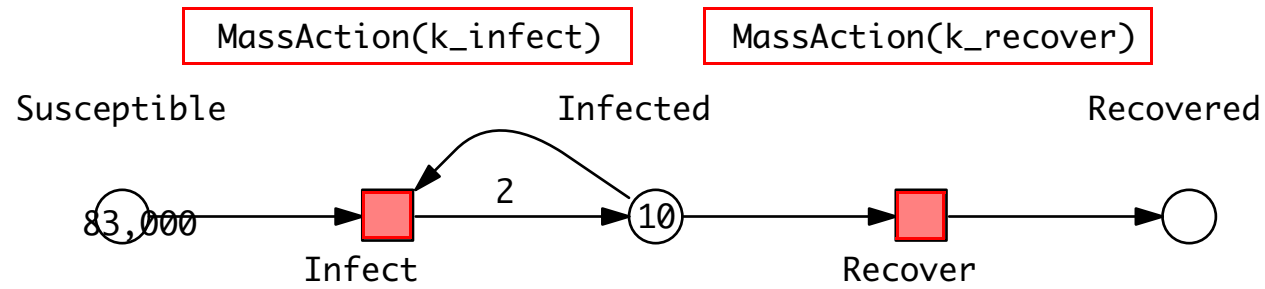

## THE SIR MODEL

[ [https://en.wikipedia.org/wiki/Compartmental\\_models\\_in\\_epidemiology#The\\_SIR\\_model](https://en.wikipedia.org/wiki/Compartmental_models_in_epidemiology#The_SIR_model) ]

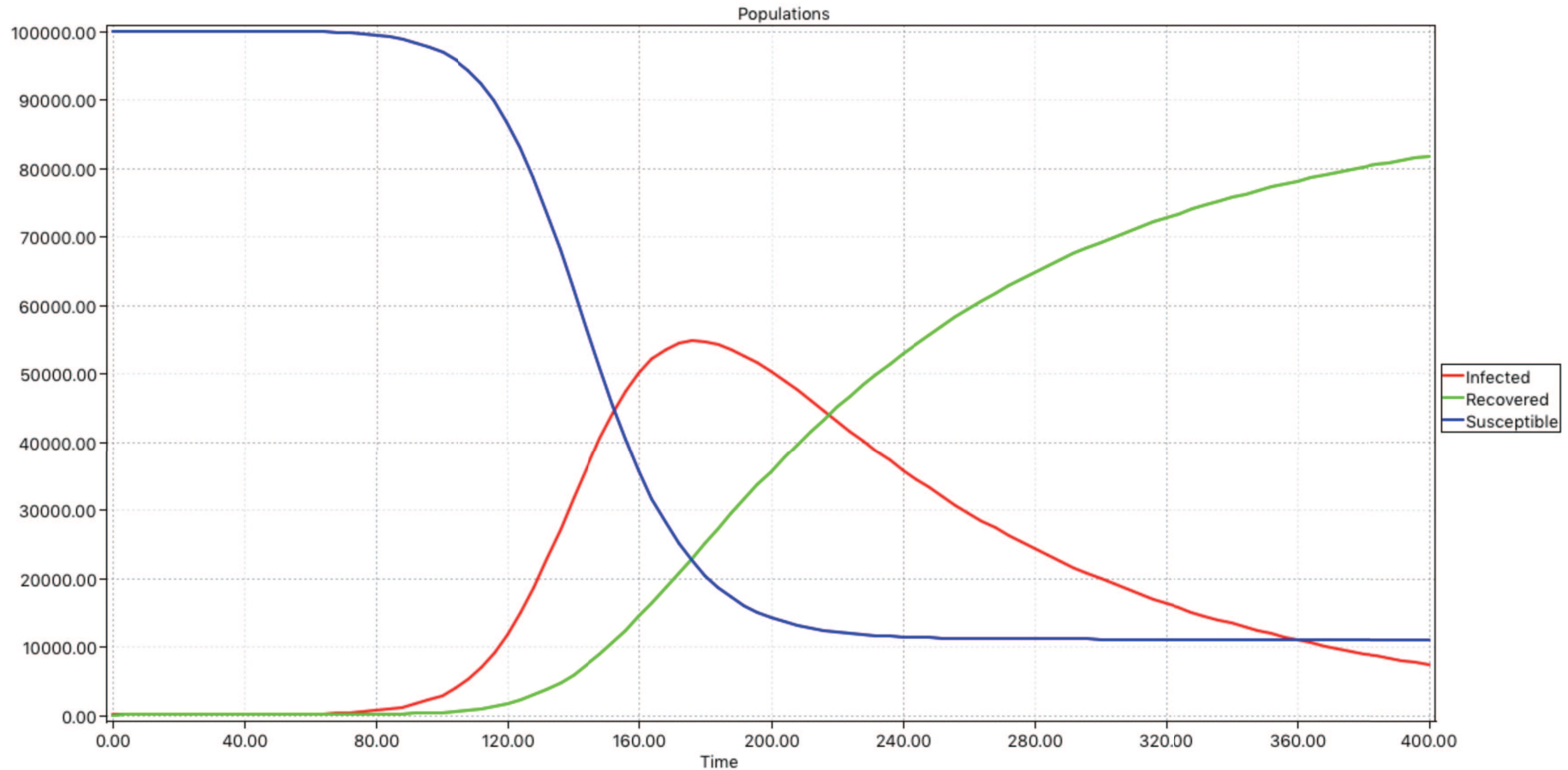

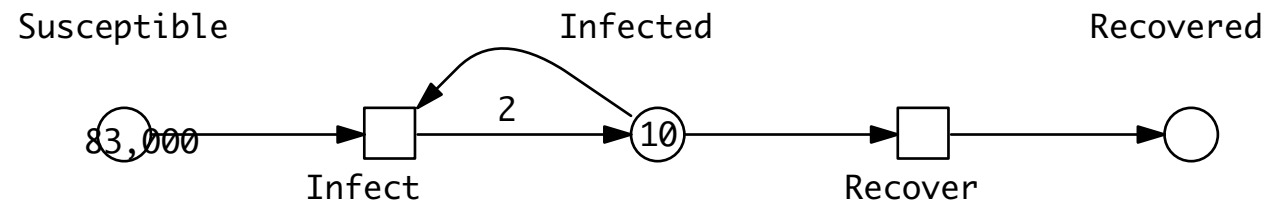

JOINT WORK WITH DAVID GILBERT, SHANNON CONNOLLY, BRUNEL UNIVERSITY, LONDON

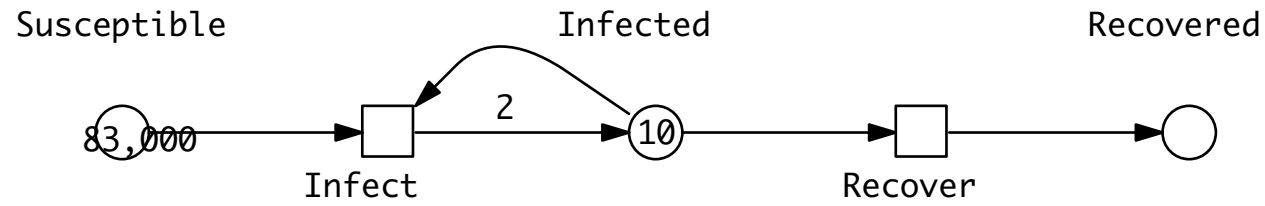

JOINT WORK WITH DAVID GILBERT, SHANNON CONNOLLY, BRUNEL UNIVERSITY, LONDON



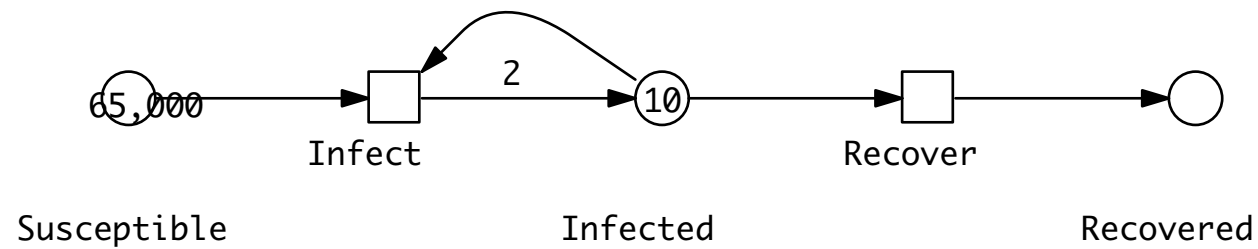
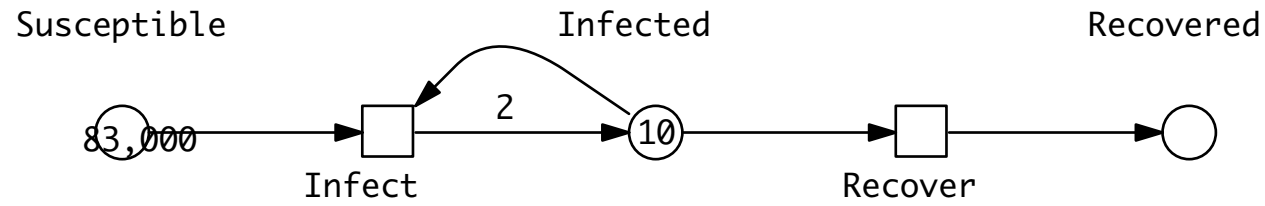

JOINT WORK WITH DAVID GILBERT, SHANNON CONNOLLY, BRUNEL UNIVERSITY, LONDON

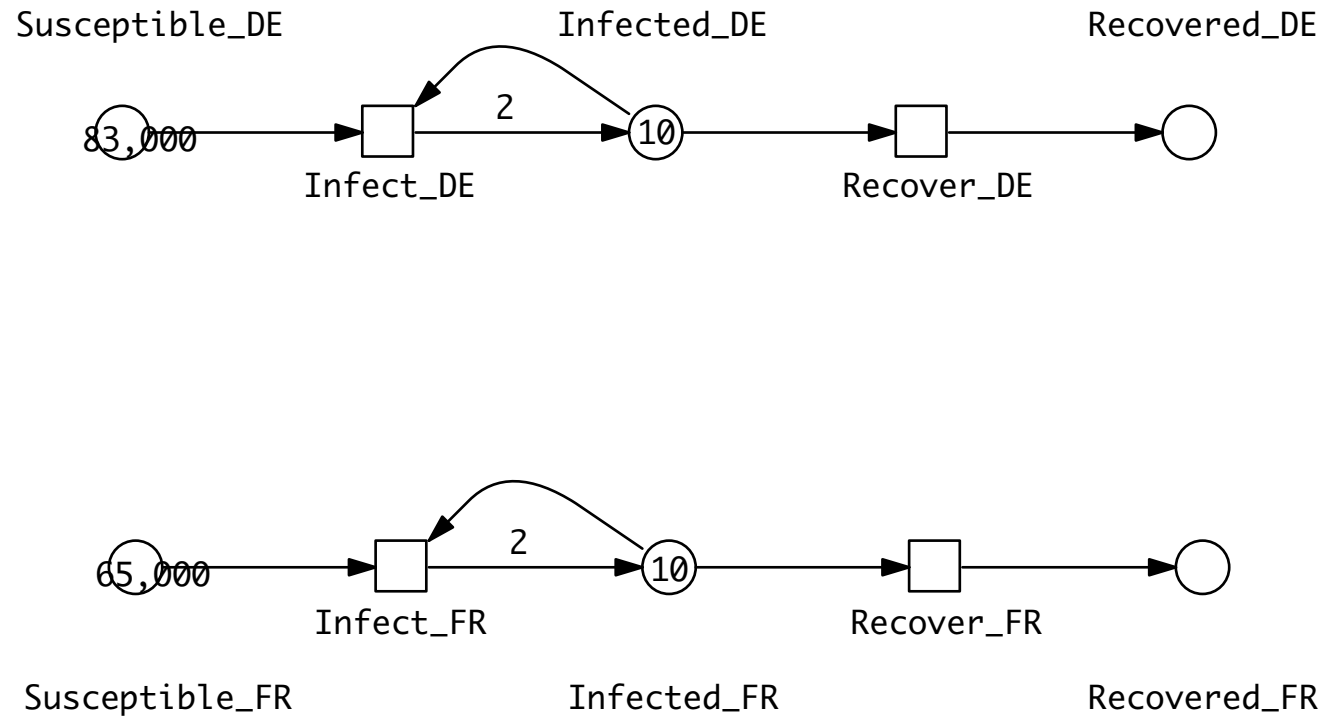

JOINT WORK WITH DAVID GILBERT, SHANNON CONNOLLY, BRUNEL UNIVERSITY, LONDON

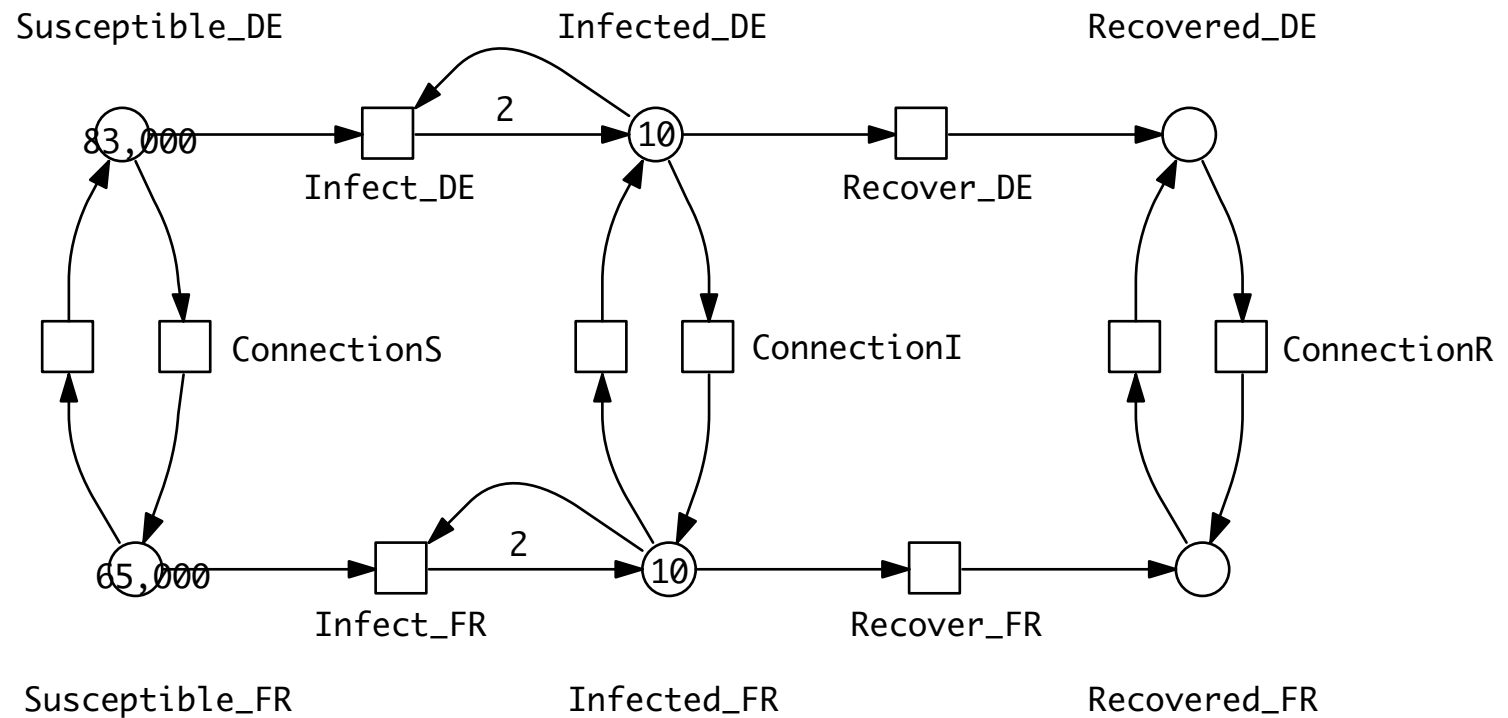

JOINT WORK WITH DAVID GILBERT, SHANNON CONNOLLY, BRUNEL UNIVERSITY, LONDON

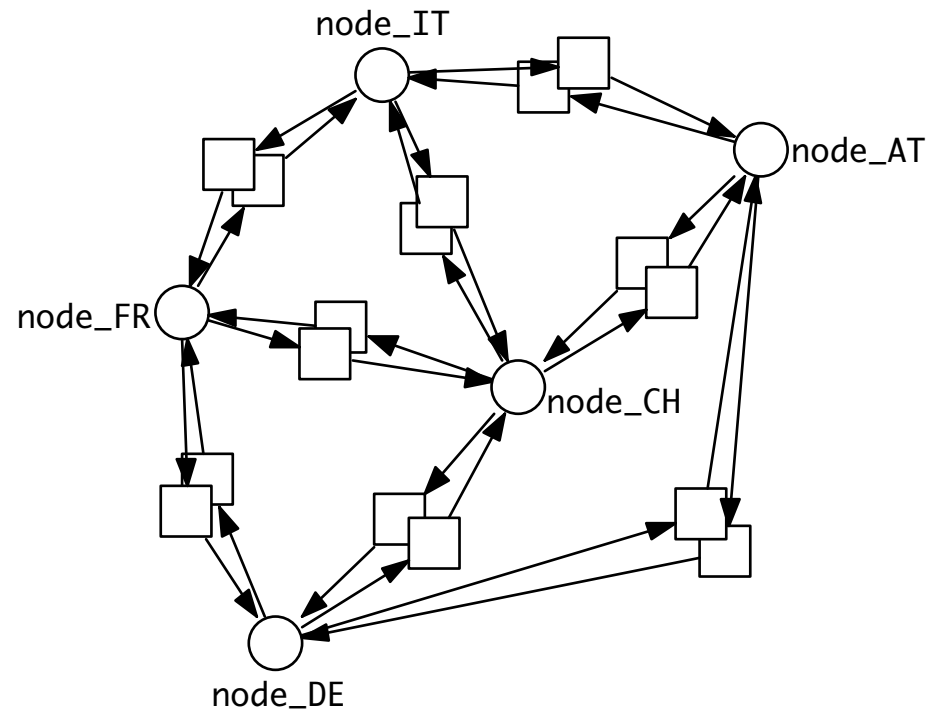

**AT,  
CH,  
DE,  
FR,  
IT**

**JOINT WORK WITH DAVID GILBERT, SHANNON CONNOLLY, BRUNEL UNIVERSITY, LONDON**

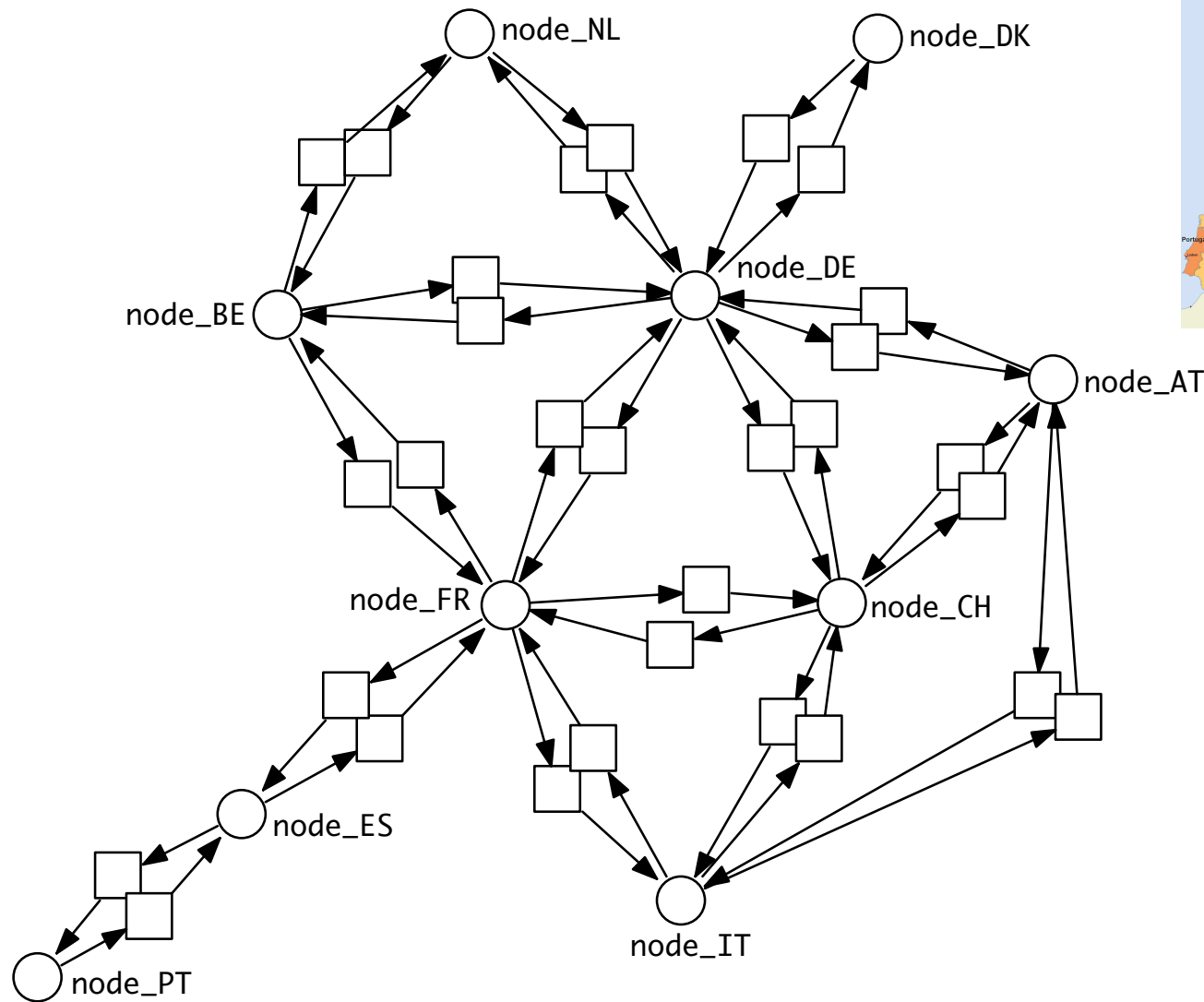

**WESTERN  
EUROPE**

**JOINT WORK WITH DAVID GILBERT, SHANNON CONNOLLY, BRUNEL UNIVERSITY, LONDON**

# EPIDEMIC -> PANDEMIC MODELLING

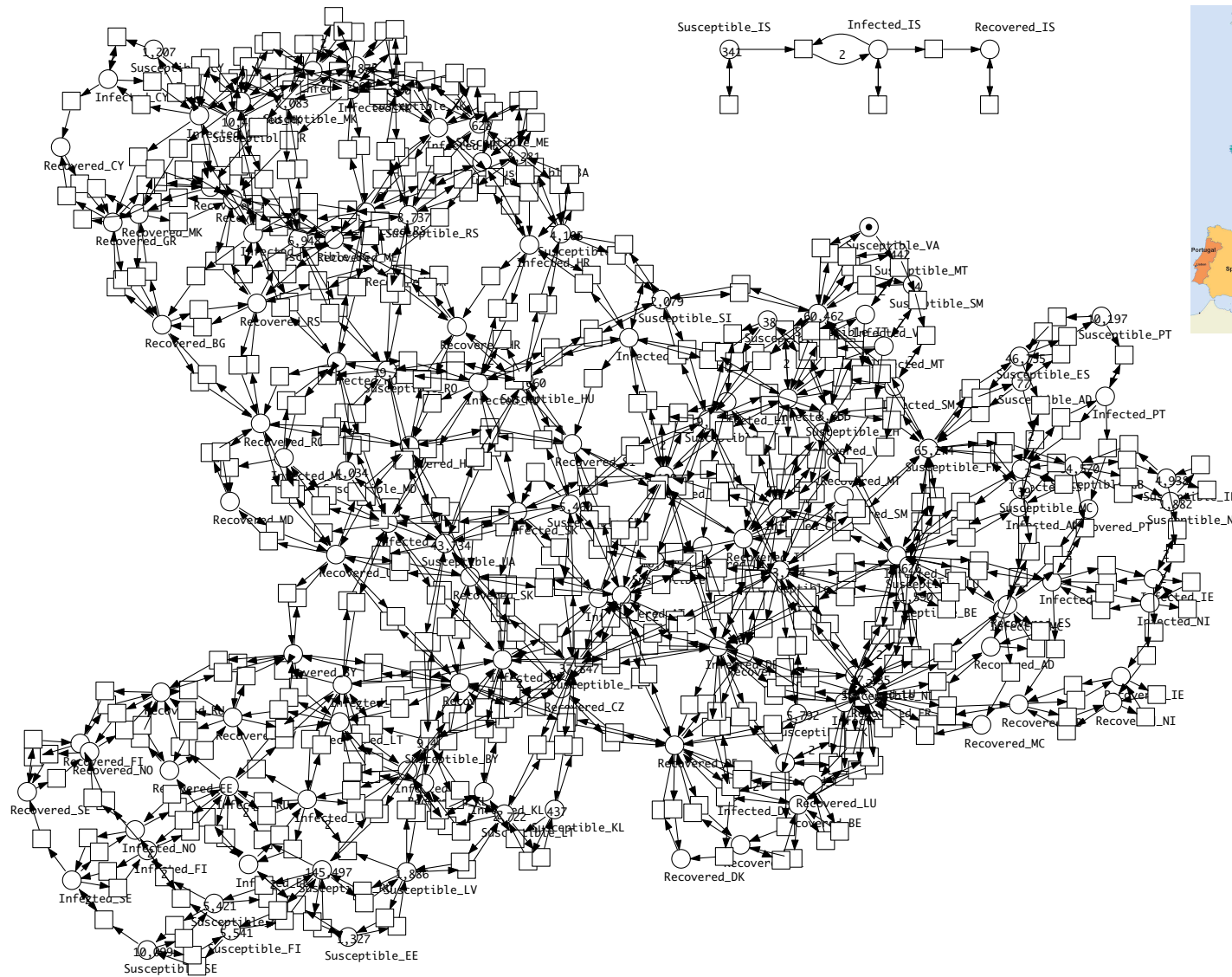

EUROPE

JOINT WORK WITH DAVID GILBERT, SHANNON CONNOLLY, BRUNEL UNIVERSITY, LONDON

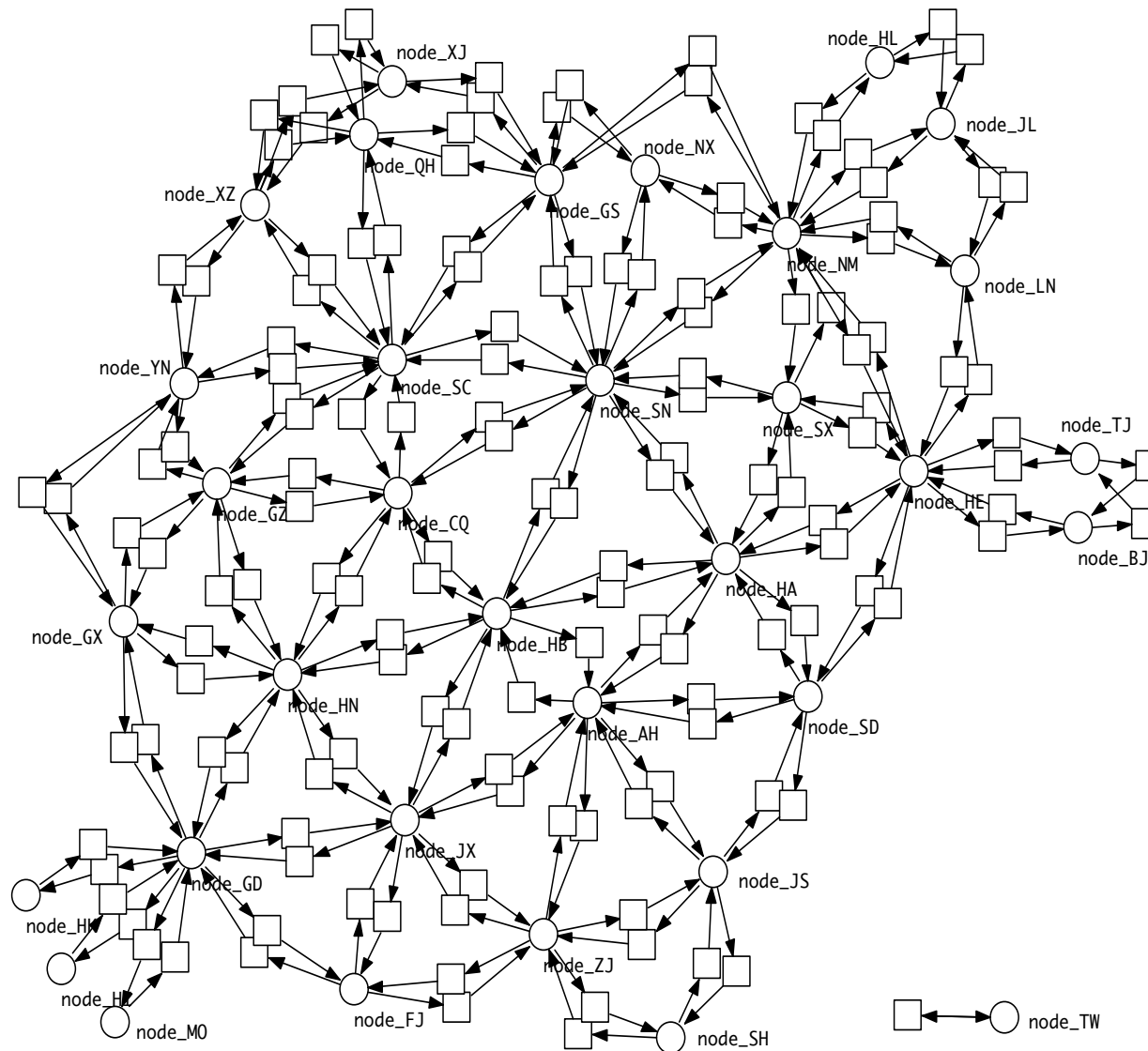

**JOINT WORK WITH DAVID GILBERT, SHANNON CONNOLLY, BRUNEL UNIVERSITY, LONDON**

# EPIDEMIC -> PANDEMIC MODELLING

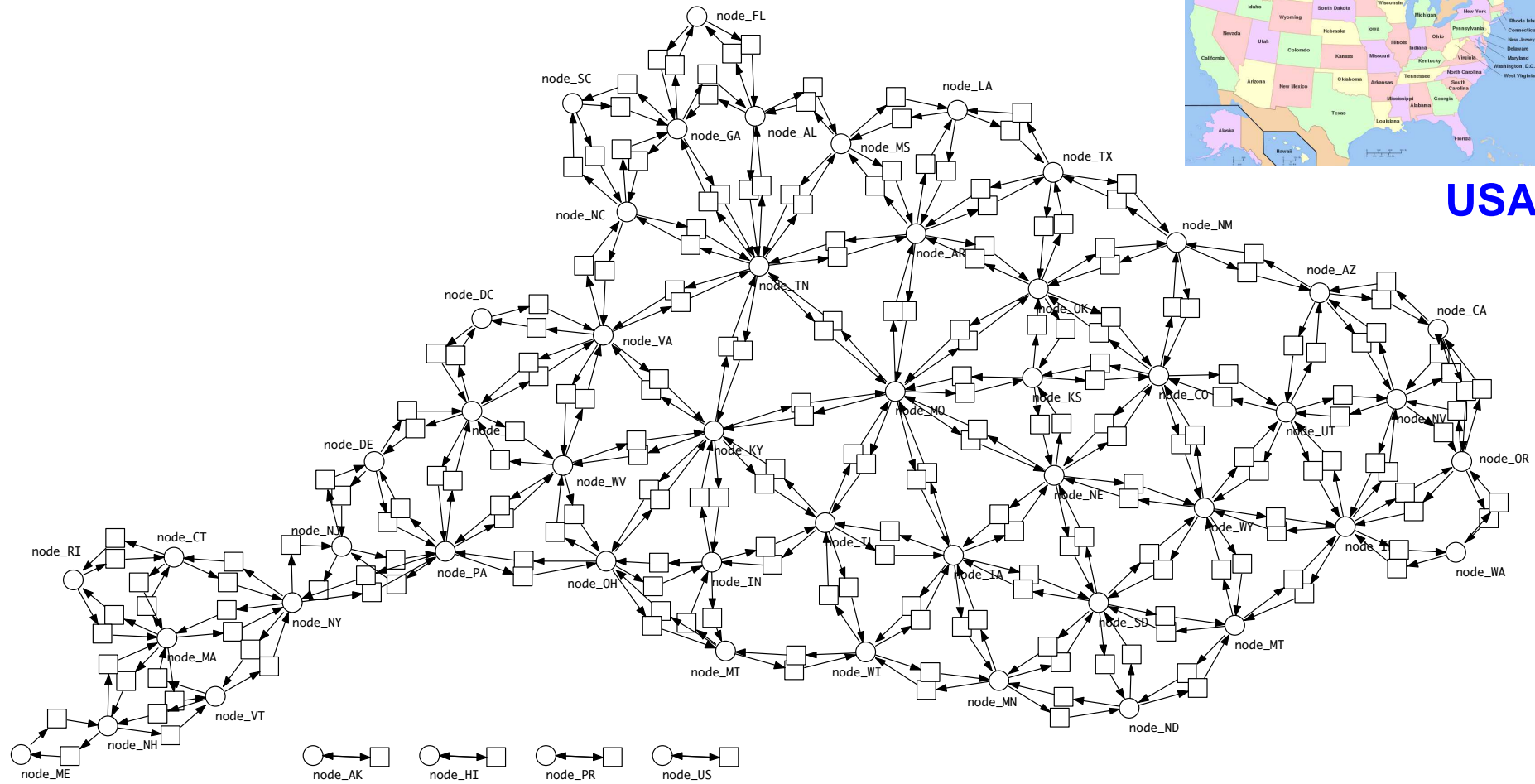

JOINT WORK WITH DAVID GILBERT, SHANNON CONNOLLY, BRUNEL UNIVERSITY, LONDON



AND THEN THERE WAS COLOUR

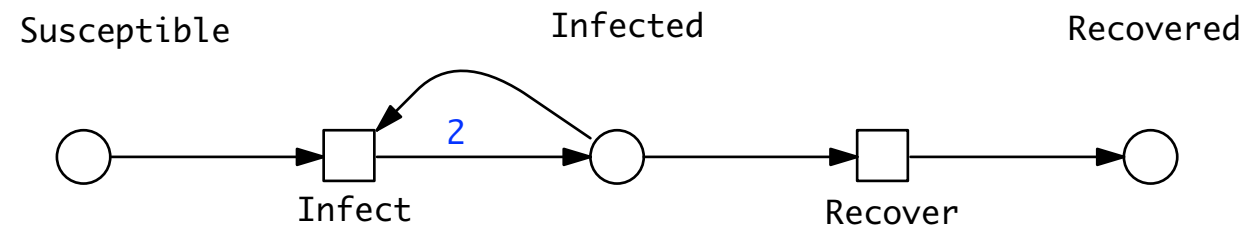

**JOINT WORK WITH DAVID GILBERT, SHANNON CONNOLLY, BRUNEL UNIVERSITY, LONDON**

**colorsets:**

```
enum Nodes = {AT, CH, DE, FR, IT};
```

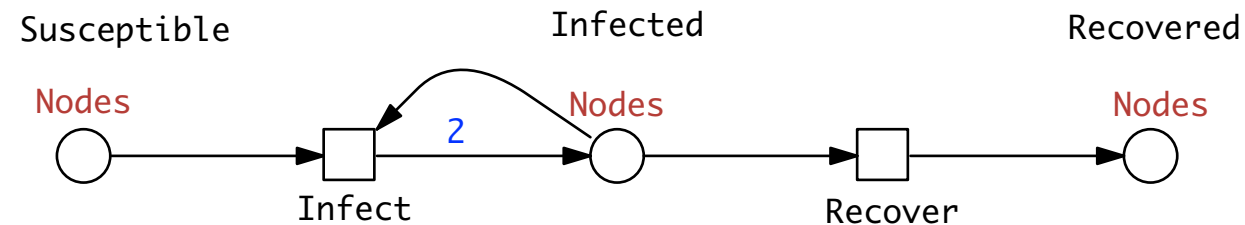

**JOINT WORK WITH DAVID GILBERT, SHANNON CONNOLLY, BRUNEL UNIVERSITY, LONDON**

## colorsets:

```
enum Nodes = {AT, CH, DE, FR, IT};
```

## variables:

```
Nodes : x;
```

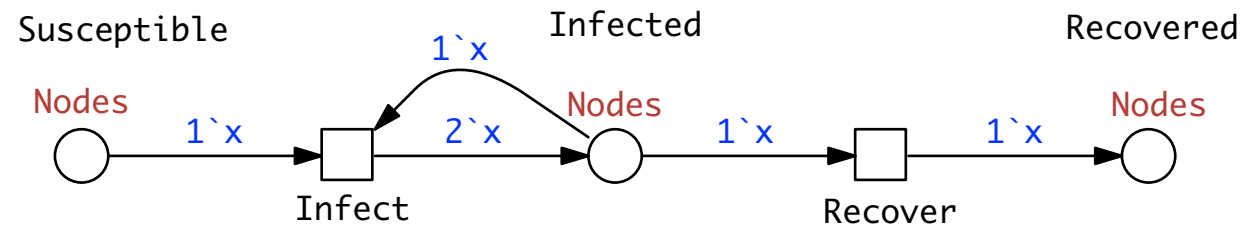

JOINT WORK WITH DAVID GILBERT, SHANNON CONNOLLY, BRUNEL UNIVERSITY, LONDON

## colorsets:

```
enum Nodes = {AT, CH, DE, FR, IT};
```

## variables:

```
Nodes : x;
```

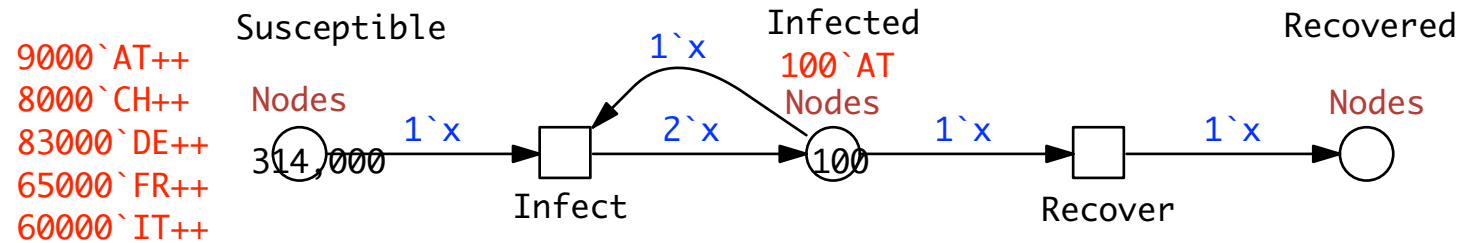

JOINT WORK WITH DAVID GILBERT, SHANNON CONNOLLY, BRUNEL UNIVERSITY, LONDON

## colorsets:

```
enum Nodes = {AT, CH, DE, FR, IT};
```

## variables:

```
Nodes : x; Nodes : y;
```

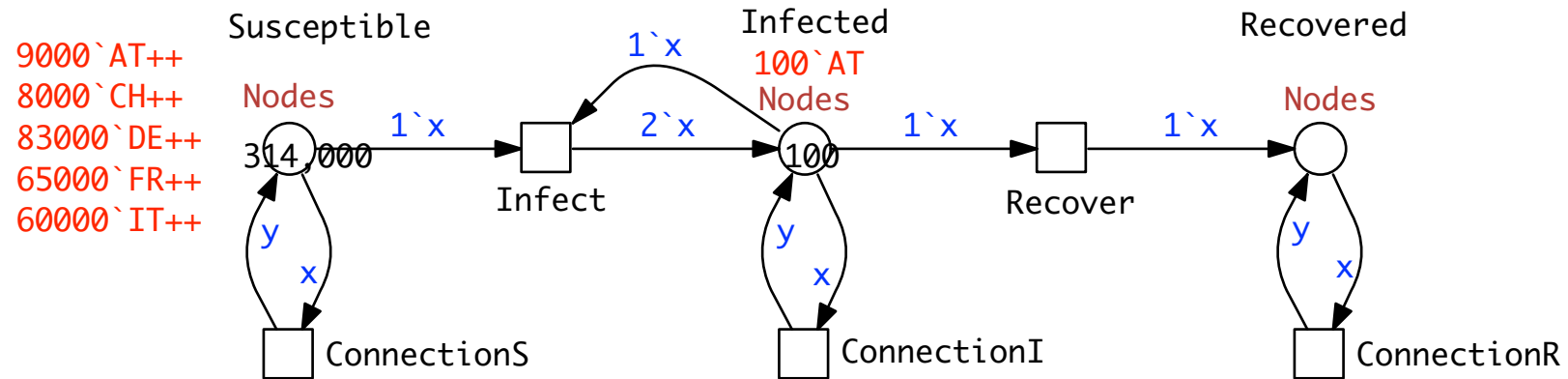

JOINT WORK WITH DAVID GILBERT, SHANNON CONNOLLY, BRUNEL UNIVERSITY, LONDON

## colorsets:

enum Nodes = {AT, CH, DE, FR, IT};

## variables:

Nodes : x; Nodes : y;

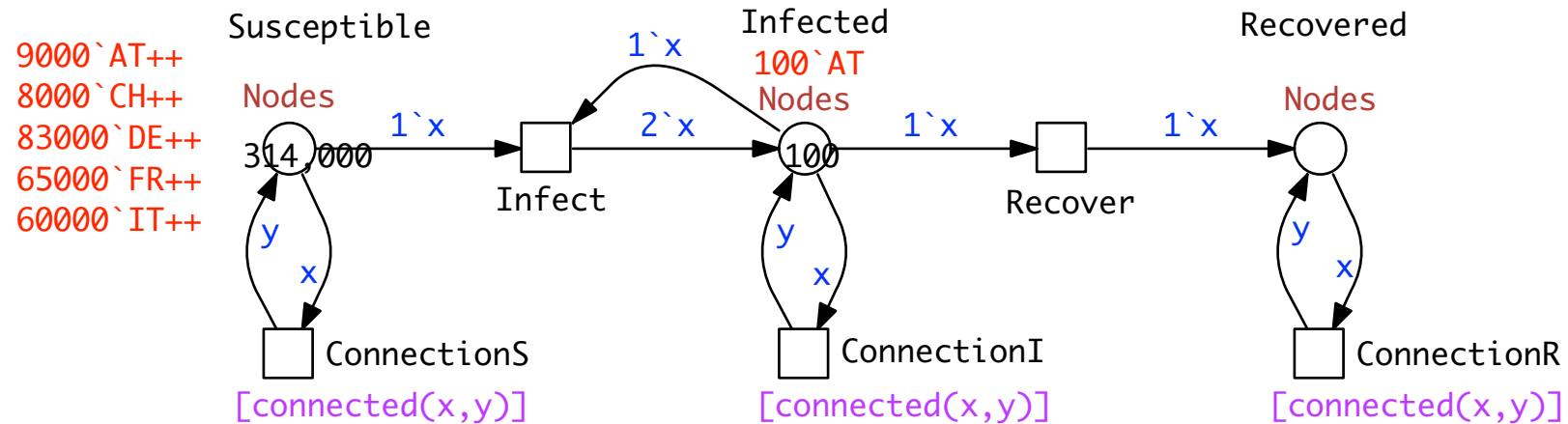

JOINT WORK WITH DAVID GILBERT, SHANNON CONNOLLY, BRUNEL UNIVERSITY, LONDON

## colorsets:

```
enum Nodes = {AT, CH, DE, FR, IT};
```

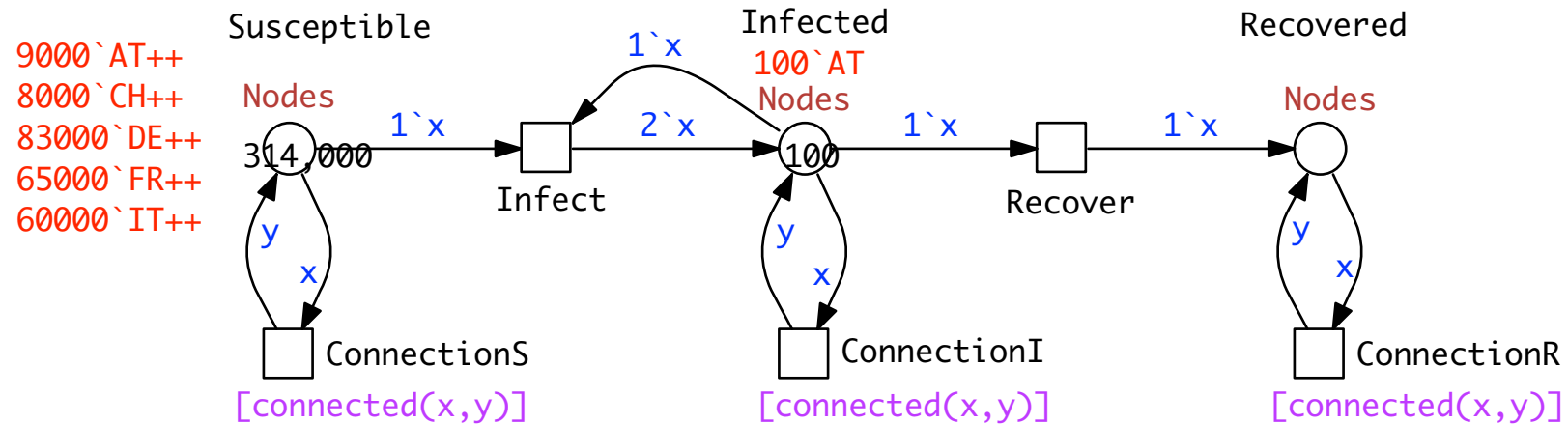

JOINT WORK WITH DAVID GILBERT, SHANNON CONNOLLY, BRUNEL UNIVERSITY, LONDON



## colorsets:

```
enum Nodes = {AT, CH, DE, FR, IT};  
Matrix = PROD (Nodes, Nodes);
```

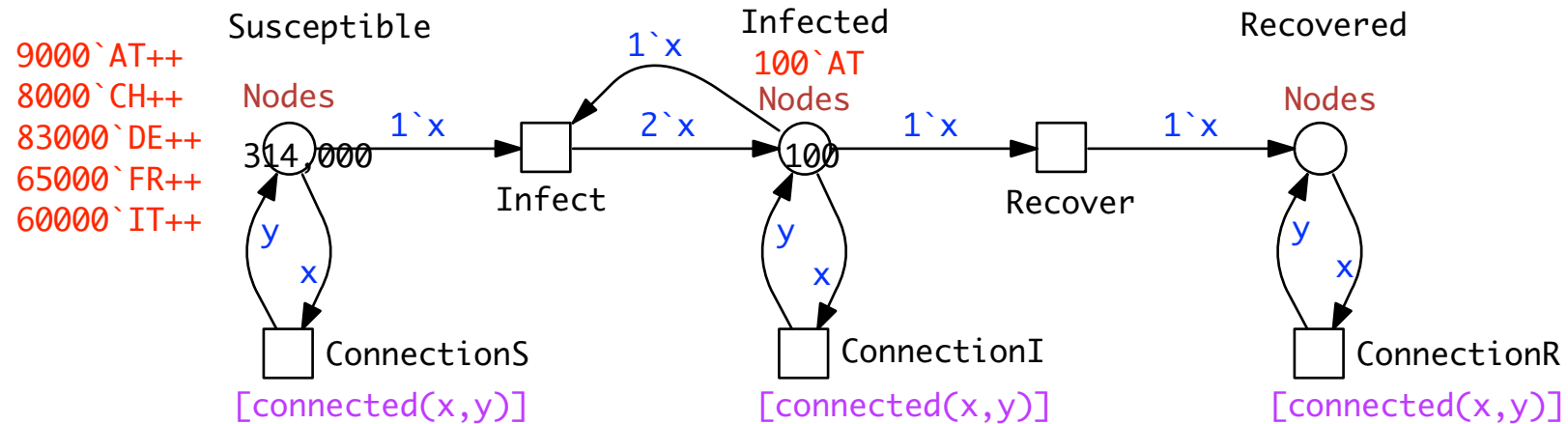

JOINT WORK WITH DAVID GILBERT, SHANNON CONNOLLY, BRUNEL UNIVERSITY, LONDON

## colorsets:

```
enum Nodes = {AT, CH, DE, FR, IT};
```

```
Matrix = PROD (Nodes, Nodes);
```

```
Connections = Matrix [ (x=AT & (y=CH | y=DE | y=IT) |  
                        (x=CH & (y=AT | =E | y=FR | y=IT) | ... );
```

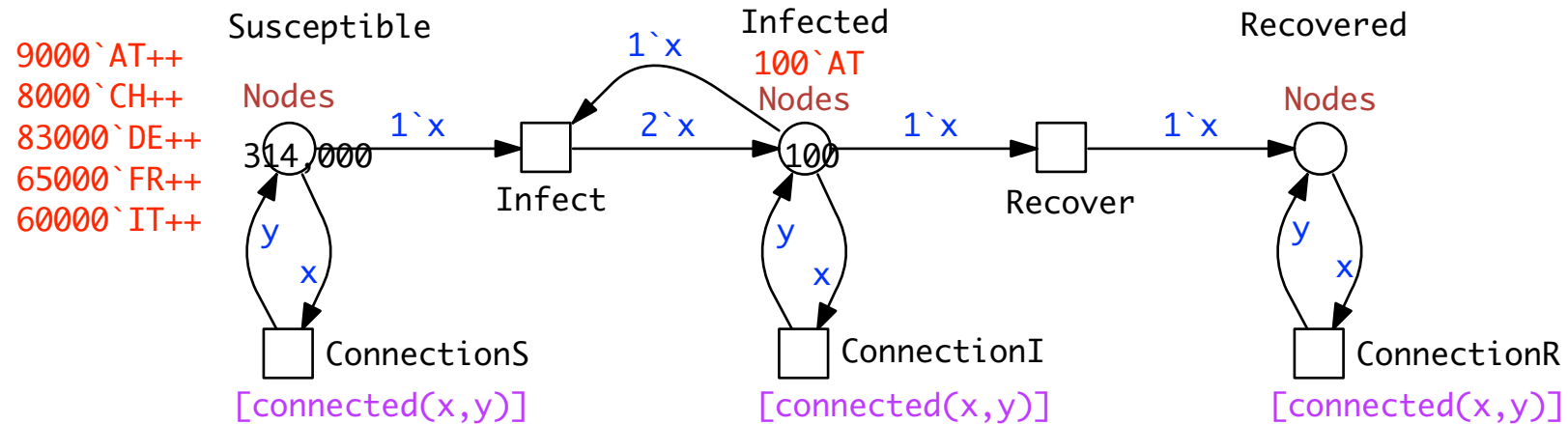

JOINT WORK WITH DAVID GILBERT, SHANNON CONNOLLY, BRUNEL UNIVERSITY, LONDON

## colorsets:

```
enum Nodes = {AT, CH, DE, FR, IT};
```

```
Matrix = PROD (Nodes, Nodes);
```

```
Connections = Matrix [ (x=AT & (y=CH | y=DE | y=IT) |  
                        (x=CH & (y=AT | =E | y=FR | y=IT) | ... );
```

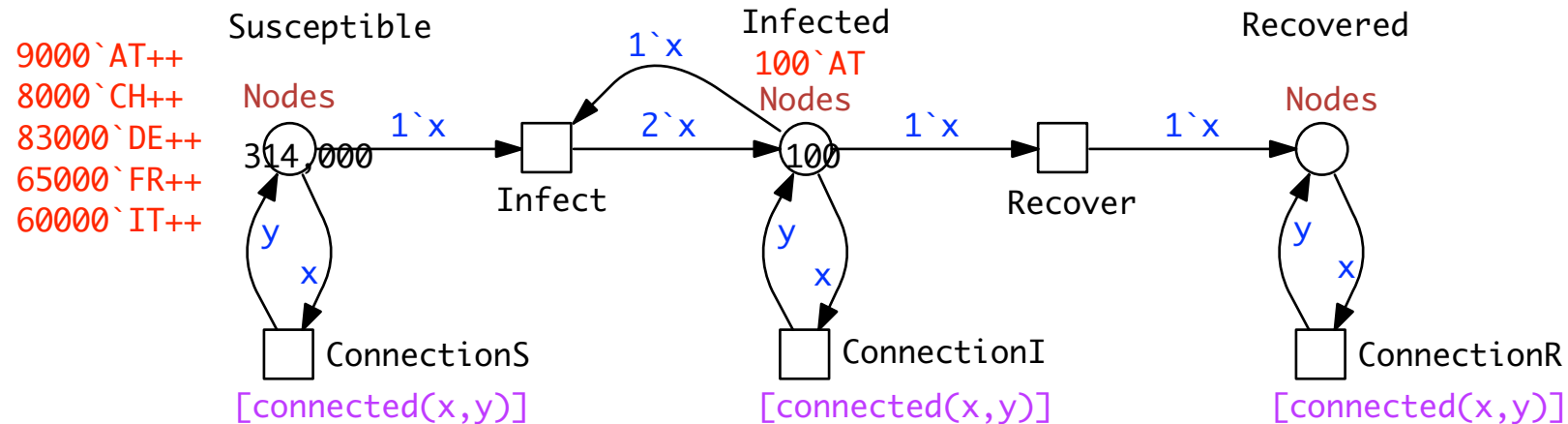

## colorfunction:

```
bool connected (Nodes p, Nodes q) { (p,q) elemOf Connections };
```

JOINT WORK WITH DAVID GILBERT, SHANNON CONNOLLY, BRUNEL UNIVERSITY, LONDON

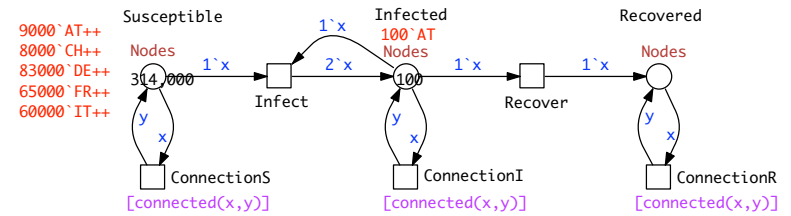

AT,  
CH,  
DE,  
FR,  
IT



JOINT WORK WITH DAVID GILBERT, SHANNON CONNOLLY, BRUNEL UNIVERSITY, LONDON

# PANDEMIC MODELLING WITH COLOURED NETS

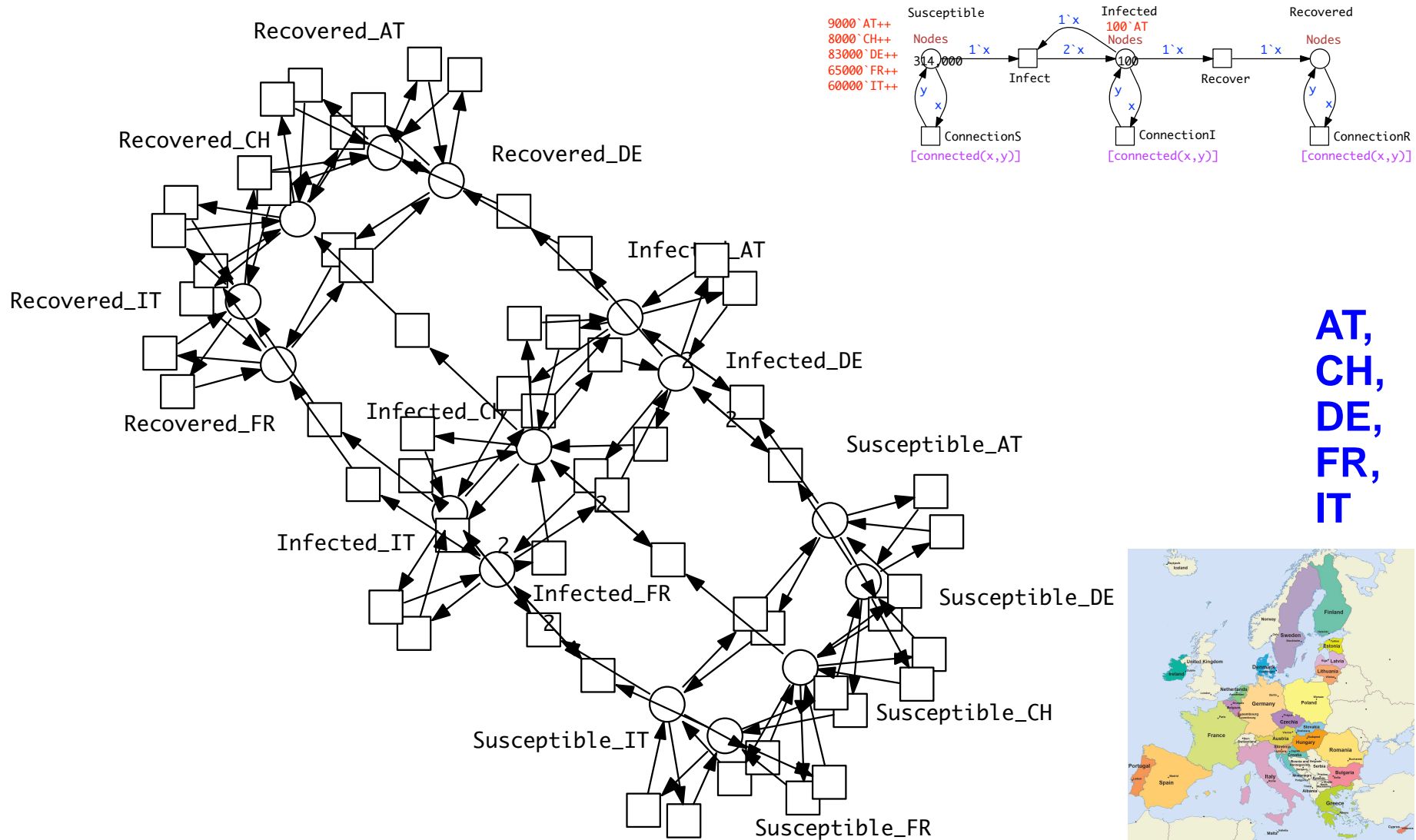

JOINT WORK WITH DAVID GILBERT, SHANNON CONNOLLY, BRUNEL UNIVERSITY, LONDON

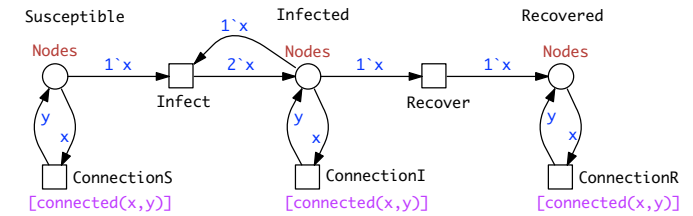
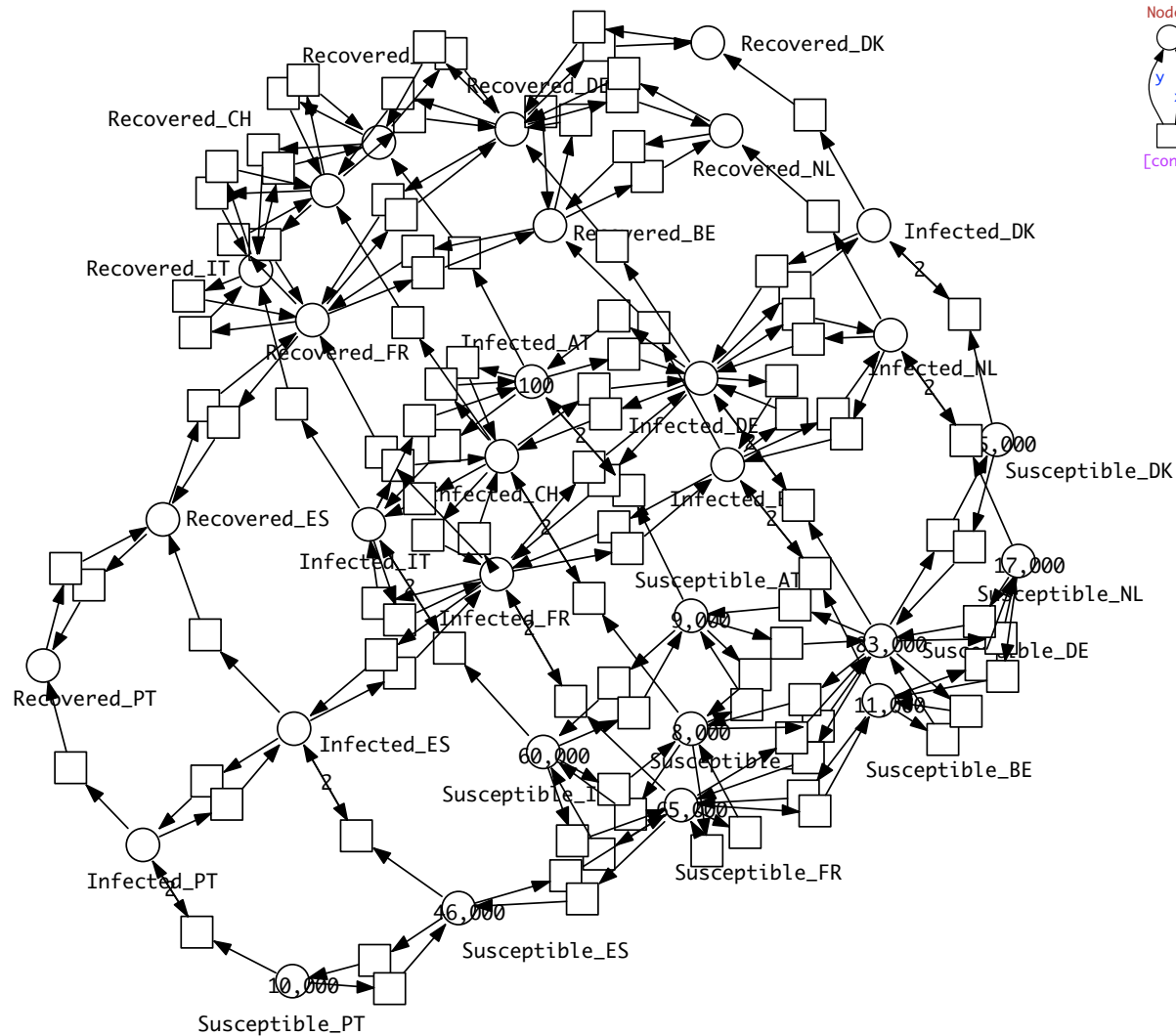

**WESTERN  
EUROPE**



**JOINT WORK WITH DAVID GILBERT, SHANNON CONNOLLY, BRUNEL UNIVERSITY, LONDON**

# PANDEMIC MODELLING WITH COLOURED NETS

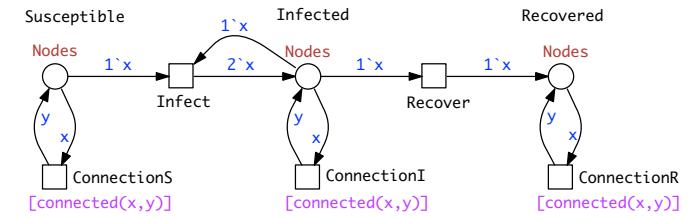
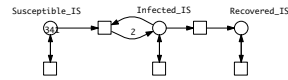
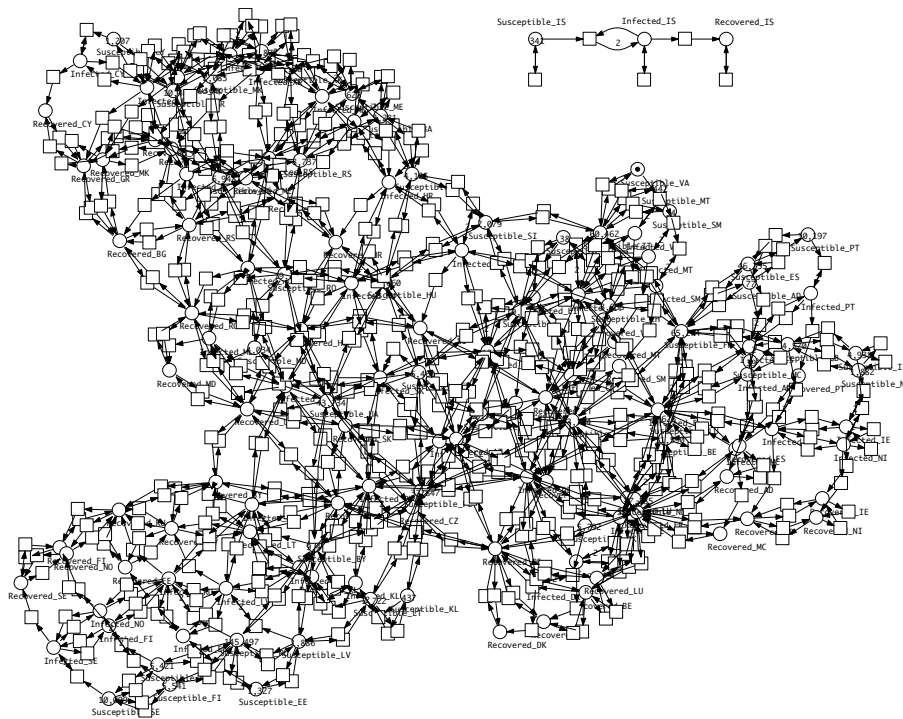

**EUROPE**

**JOINT WORK WITH DAVID GILBERT, SHANNON CONNOLLY, BRUNEL UNIVERSITY, LONDON**

# PANDEMIC MODELLING WITH COLOURED NETS

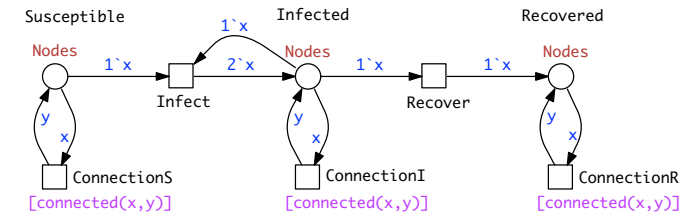
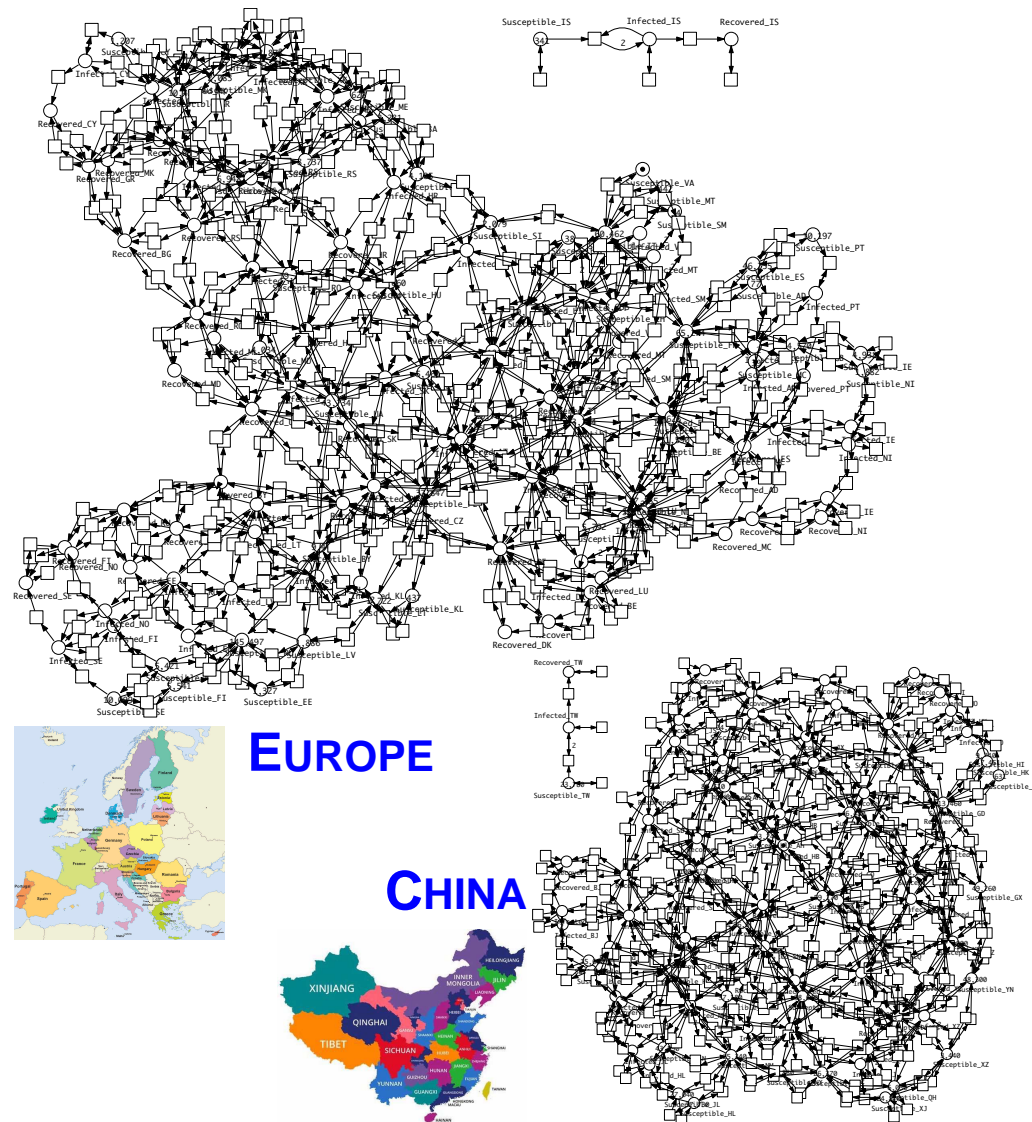

JOINT WORK WITH DAVID GILBERT, SHANNON CONNOLLY, BRUNEL UNIVERSITY, LONDON



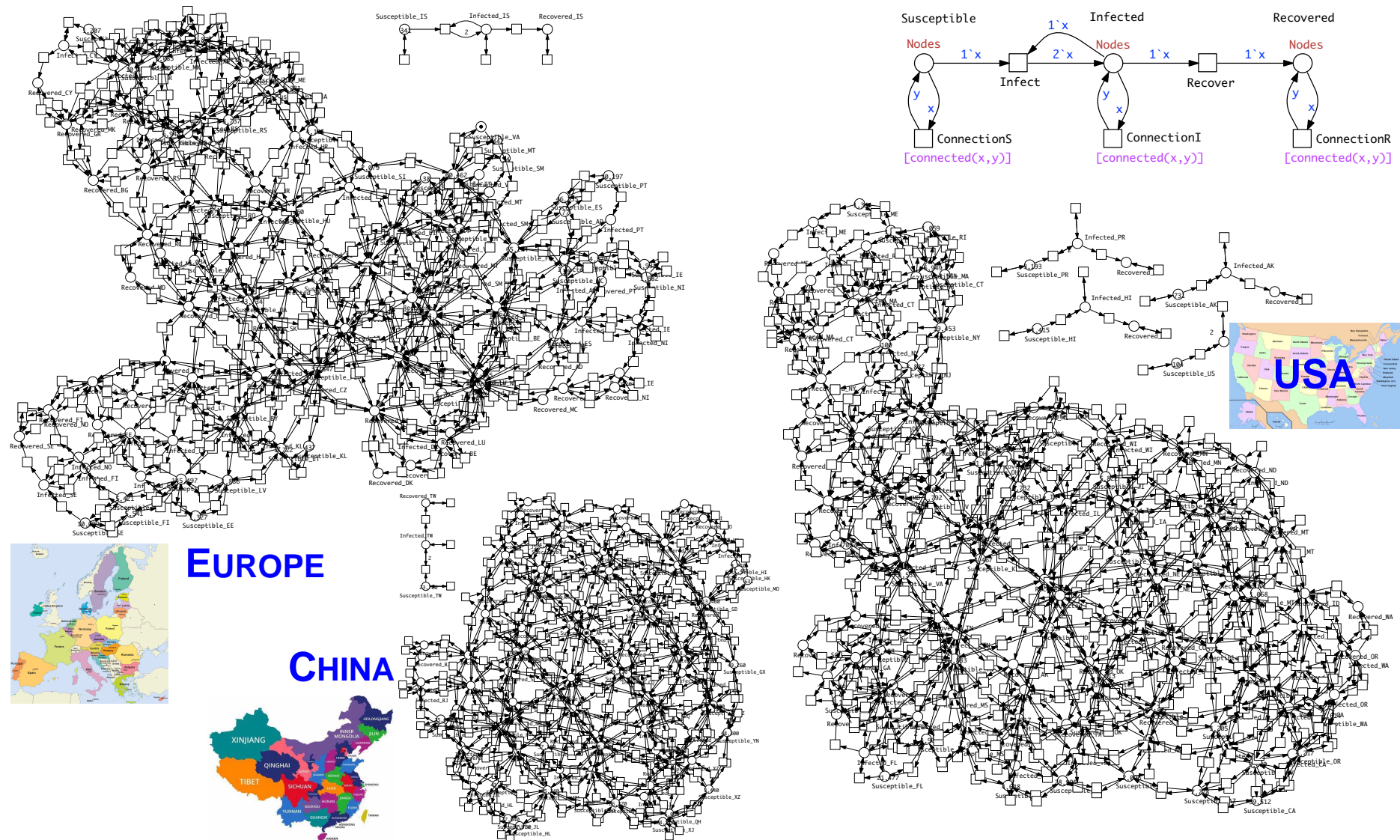

JOINT WORK WITH DAVID GILBERT, SHANNON CONNOLLY, BRUNEL UNIVERSITY, LONDON

# WHAT NEEDS TO BE CHANGED: COLOUR SETS + INITIAL MARKING

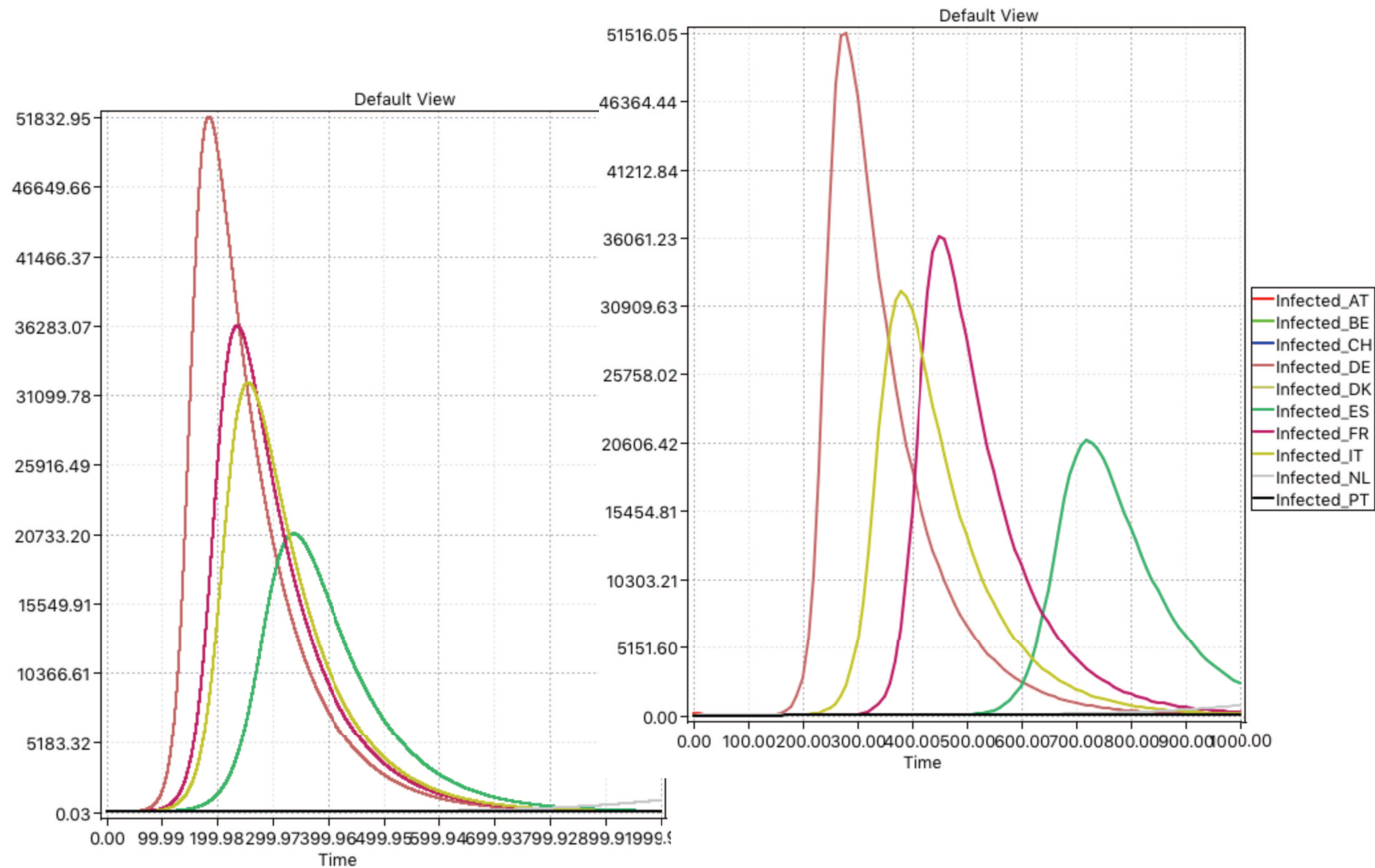

**JOINT WORK WITH DAVID GILBERT, SHANNON CONNOLLY, BRUNEL UNIVERSITY, LONDON**

# HOW TO UNFOLD EFFICIENTLY ?

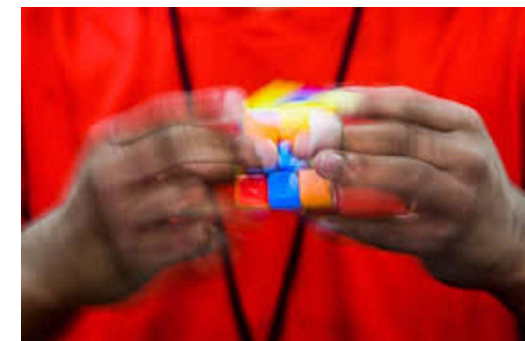
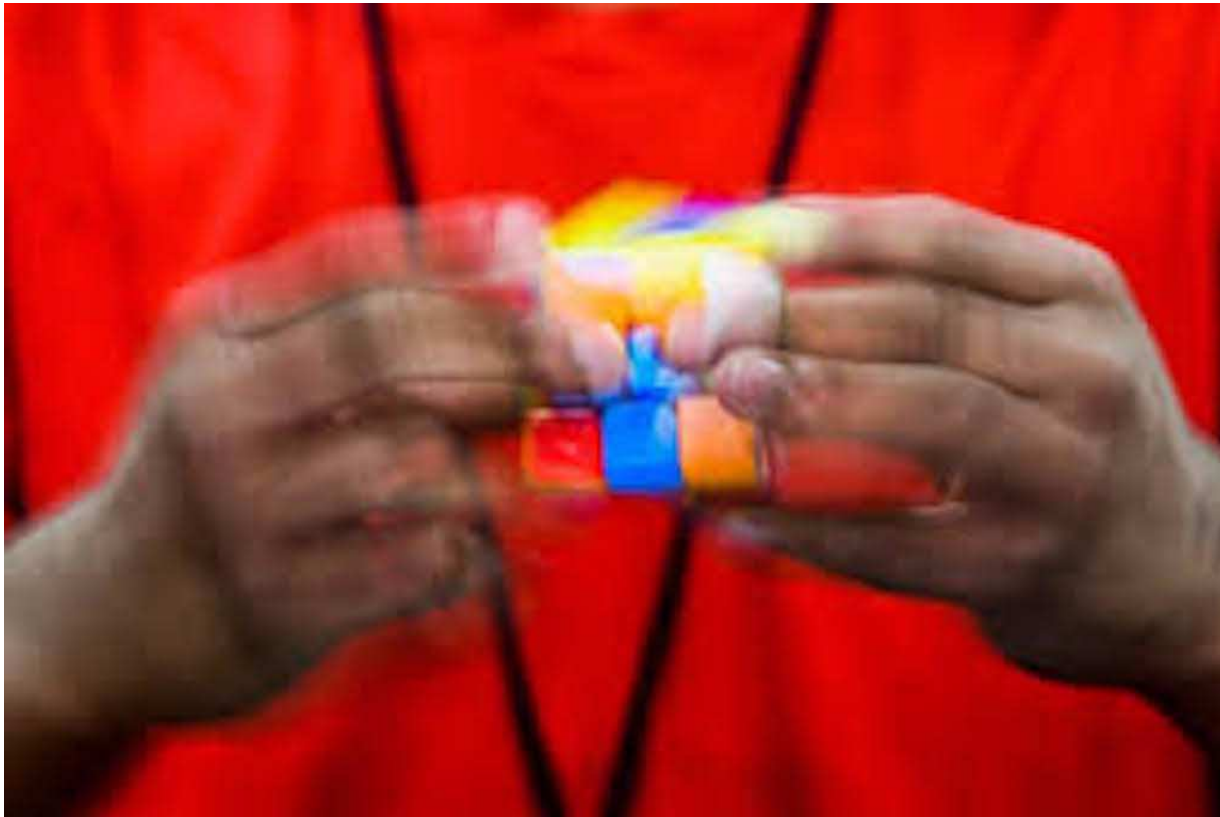

## HOW TO UNFOLD EFFICIENTLY ?



**SNOOPY  
MARCIE  
SPIKE**

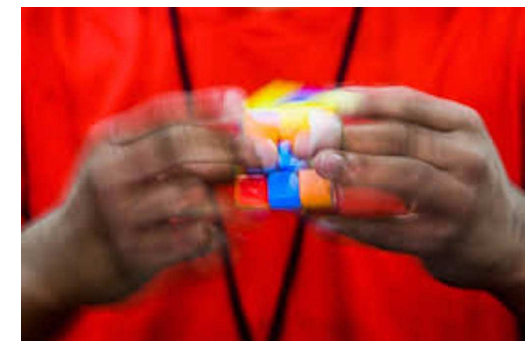

**HOW TO UNFOLD EFFICIENTLY ?**

**[WWW-DSSZ.INFORMATIK.TU-COTTBUS.DE](http://WWW-DSSZ.INFORMATIK.TU-COTTBUS.DE)**